

MOVING YOU FURTHER

210

SMART



*Photo may include optional equipment

Engine Rated Power

139 HP (104 KW) @2000 rpm

Operating Weight

21,200 kg

Bucket Capacity

0.92 m³ GP / 0.87 m³ RB

 **HYUNDAI**
CONSTRUCTION EQUIPMENT
INDIA



Designed for SMART work



OPERATOR COMFORT



Ergonomically placed operator controls with spacious AC cabin & fully adjustable seat provides perfect working environment and reduces operator fatigue in long working hours.

BEST-IN CLASS PERFORMANCE



Hyundai's advanced CAPO technology added with hydraulic flow summation and regeneration ensures faster cycle time. The new series machine comes with additional bucket link reinforcement to support excellent bucket dig and arm crowd forces.

INCREASED MACHINE DURABILITY



Idler area track reinforcement to withstand Indian territorial conditions and heavy duty applications.



BETTER VISIBILITY

Cabin roof lights provide enhanced visibility and enable the operator to work at night with ease.



LOW MAINTENANCE

Air pre-cleaner extends air filter servicing cycle which results in lower operating cost per hour.



NEW GENERATION STYLING

All new aesthetics with dual tone color cabin for 'SMART' look.



IMPROVED FUEL EFFICIENCY

Upgraded circuit design, added sensor controls & advanced hydraulics for variable load sensing have been designed for improved fuel efficiency.



ENHANCED DURABILITY

Forged ring body to enhance the structural integrity adds to the durability of machine.



SMART - Superior Performance



ENGINE

The water cooled, 4 cycle diesel, 6 cylinder in line, direct injection turbocharged engine is built for power, reliability, efficiency and reduced emissions. The engine is manufactured to perform in wide range of heat, humidity and dust conditions without compromising productivity.

HYDRAULICS

Hydraulic pump installed in Hyundai is variable displacement axial piston type with electro hydraulic control function. This system provides wide range of flow at various workloads for paramount productivity. Open center design of Main Control Valve (MCV) with port relief valves & spools ensures fast response and maximum efficiency in extreme conditions. Travel & swing motor speeds provide excellent mobility for improved cycle time.



SWING PRIORITY



Swing priority spool is auto piloted which boosts higher hydraulic energy to swing circuitry. This leads to faster swing cycle which in turn results in more output & better performance.

ARM REGENERATION

Arm regeneration system helps to recirculate hydraulic energy from return line and adds to pump supply line. It provides smooth operation of arm preventing cavitation and increasing performance of machine.

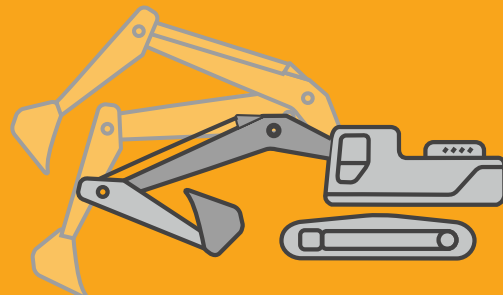

NEGATIVE FLOW CONTROL



Pump flow is proportionally regulated with control lever stroke which saves fuel by regulating pump and engine. It maintains higher standby pressure for faster response and continuous oil flow for even temperature.

FUEL SAVING KIT



Fuel saving kit contains additional sensors to monitor undue load & accordingly sends signals to controller to cut down losses. It provides up to 5% increase in fuel efficiency.

SMART - Ease of Maintenance

OPERATOR CONVENIENCE

In SMART series machine, you can easily adjust the seat, console and armrest settings to best suit your preferred comfort level. Spacious cabin with other preference settings that creates a higher grade working environment and reduces fatigue include the high capacity air conditioning system, and radio/USB player.

Additional cabin lights as standard attachment enhances visibility while doing work at night time. Added distribution of air flow through front and rear aircon ducting facilitates increased airflow distribution inside the cabin which in turn ensures operator comfort to increase operator efficiency and capacity to improve production.



EASY ACCESS & SERVICEABILITY

Easy access for maintenance means regular checks get done faster, giving you more uptime. Hyundai's SMART machines feature easy service access to increase uptime and keep maintenance to a minimum to reduce operating costs.



FUEL FILLER PUMP



Optional fuel filler pump enables refueling of fuel tank ensuring clean fuel to the engine which in turn avoids fuel contamination from atmospheric air. Also, the time required to refill is reduced to ensure higher uptime for more productivity.

EXTENDED MAINTENANCE INTERVAL



SMART series excavators are designed with long-life hydraulic filters up to 1,000 hrs, long-life hydraulic oil up to 5,000 hrs, more efficient cooling systems which extend service intervals, minimize operating costs and reduce machine down time.

SMART - Analytical Capability

COMPUTER AIDED POWER OPTIMIZATION

The engine horsepower and hydraulic horsepower together in unison through the advanced CAPO (Computer Aided Power Optimization) system, flow for the job at hand. Operator can set their own preferences for boom or swing priority, power mode selection and optional work tools at the touch of a button.

The CAPO system also provides complete self-diagnostic features and digital gauges for important information like hydraulic oil temperature, coolant temperatures and fuel level. This system interfaces with multiple sensors placed throughout the hydraulic system as well as the electronically controlled engine to provide the optimum level of engine power and hydraulic flow.

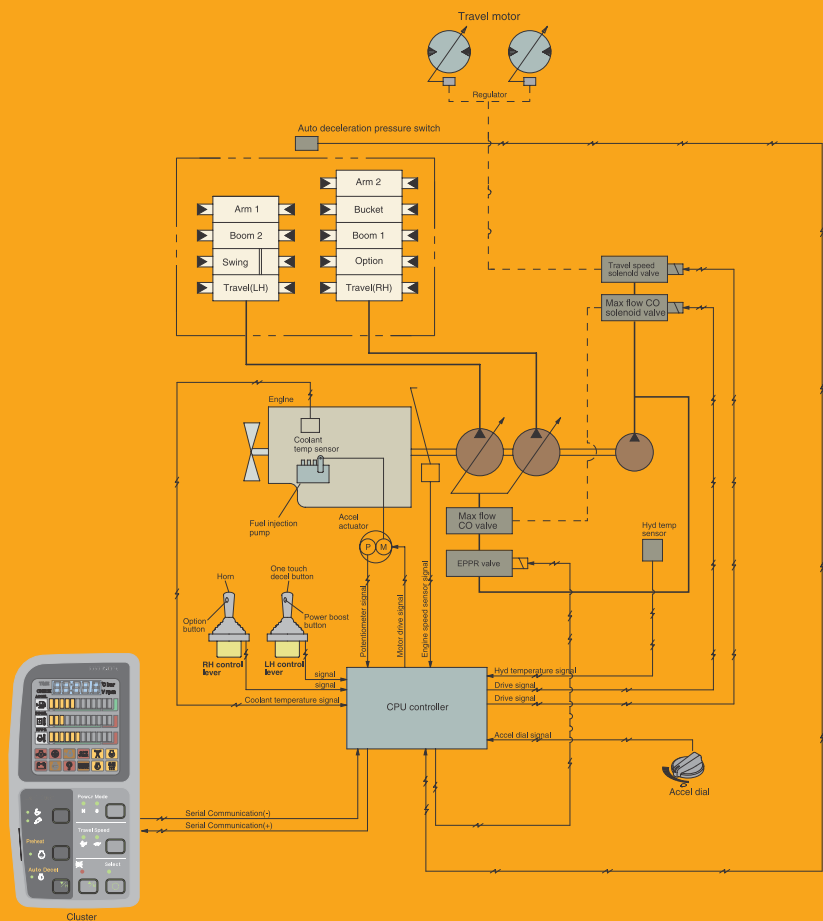

POWER MODE	H (High Power) Mode maximizes machine speed & Power for mass production. S (Standard) Mode provides a reduced, fixed RPM for optimum performance & improved fuel economy
WORK MODE	It allows the operator to select single flow attachments like Bucket & Breaker

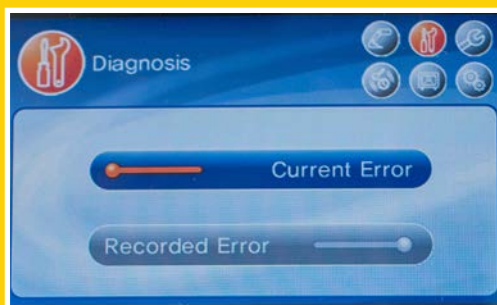

SELF-DIAGNOSTICS SYSTEM

The MCU diagnoses problems caused by machine malfunctions and displays the same on the cluster LCD monitor as error codes. The information via this device which includes engine rpm, battery voltage, hydraulic temperature and the status of electric switches allows the operator to know exact operating conditions of the machine. This makes it easier to troubleshoot any problems that occur.

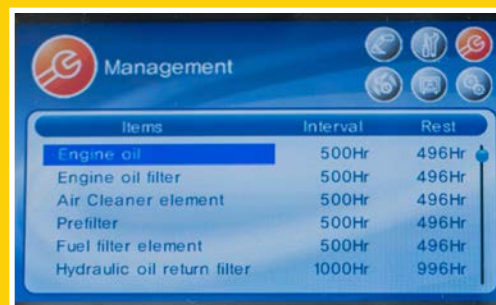

MAINTENANCE MANAGEMENT

This smart feature keeps a record of scheduled time interval for each maintenance area. It also keeps a real time update of the time duration left for the next scheduled maintenance for each and every maintenance area. This feature ensures maintenance of the machine by keeping the operator updated at all times.

SMART - Enhanced Reliability

FORGED RING BODY

New forged ring body in lower frame enhances the durability, structural integrity and increases the machine life.



AIR PRE CLEANER

Air pre-cleaner serves as a strainer for the air entering into the air filter and thus extends air filter servicing cycle which results in lower operating cost per hour.



IDLER AREA REINFORCEMENT

Added reinforcement in idler area ensures machine durability in challenging Indian environments and contribute towards a well-balanced & solid machine while operating in adverse terrains.

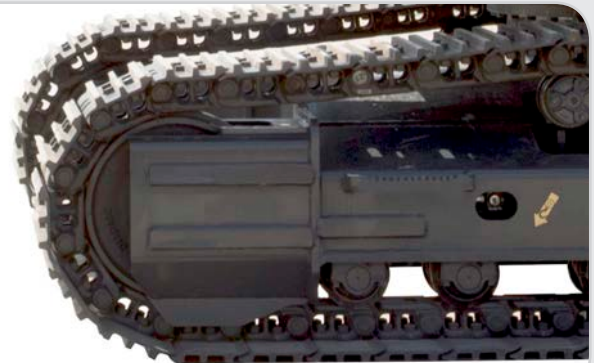

BUCKET LINK REINFORCEMENT

Bucket link reinforcement supports excellent bucket dig and arm crowd forces.



ATTACHMENTS - BUCKET

GP Bucket - Features high tensile strength steel with inner reinforcements. It is specially designed for light duty to moderate applications like earthwork and loading.

Rock Bucket - Features high tensile strength & wear resistant special alloy steel added to blade & side attack plates. Heavy duty reinforcements are added to its inner & outer body. It is excellent for stone quarry or applications involving high abrasion & impact.



STRUCTURE

The reinforced upper structure and lower frame are built to withstand tougher conditions for improved durability & reliability.



SMART - Advanced Technology

DISPLAY CLUSTER

The instrument panel is installed in front of RH console box, making it easy to check all critical systems like hydraulic oil temperature, coolant temperature and fuel level via easy-to-read indicators. Using a keypad you can make quick visual and diagnostic checks, increasing uptime and productivity.

Hyundai's unique system incorporates the work modes within the throttle control for optimum performance. When operator selects a work mode i.e. 2 power modes: H (High Power) & S (Standard), 2 work modes: bucket & breaker, the rpm is already set for maximum efficiency.



ONE TOUCH DECELERATION & AUTO IDLE

One touch deceleration switch on top of LH joystick lowers the engine RPM when selected. Engine speed is recovered to its preselected RPM when it is selected again. This system saves fuel by regulating pump and engine.

Auto Idle function moderates engine RPM to idle state when machine remains idle for 4 seconds by enabling MCU to send a signal to engine. This in turn reduces fuel consumption and operation cost.

S MODE & MAX FLOW CUT OFF



S (Standard mode) optimizes power of engine and hydraulic torque to meet desired performance at improved fuel economy



Max flow cut off system reduces pump flow for precise control during breaker use to ensure reduction in energy wastage.

New Generation Styling and Safety



BECAUSE THERE'S AN 'ART' IN 'SMART'

Hyundai's new SMART avatar comes with stylish decals & unique dual tone cabin making it peppier than ever before. And with that stylish dual tone look you can have a machine that's eye catching too.

SAFETY - MORE THAN A PEACE OF MIND. TOTAL CONFIDENCE

Cabin is integrally welded with low-stress using high strength steel to provide enhanced protection. Handrails and steps are provided for easy operation. Anti-slip pads provide safety against skidding while operating machine.



Auto engine overheat prevention function monitors coolant temperature & if high temperature is detected, the CPU controller automatically lowers the engine speed and hence cooling down the engine.

Anti-restart system prevents starter from restarting during engine operation even if operator accidentally turns on start key again.

Safety lever ensures safeguarding against machine movements by preventing hydraulic functions of machine until it is released.

Counterbalance works as a hydrostatic brake and prevents machine against accidental roll down in steep gradients.

Holding valve prevent attachments from drifting against gravity due to prolonged overhanging.

Specifications

ENGINE

MODEL		CUMMINS 6BT5.9-C	
Type		Water Cooled, 4 cycle diesel, 6 cylinder in line, direct injection turbocharged	
Rated fly-wheel horse power	SAE	J1995 (gross)	139 HP (104 KW) @ 2000 rpm
		J1349 (net)	136 HP (101 KW) @ 2000 rpm
	DIN	6271/1 (gross)	141 PS (104 KW) @ 2000 rpm
		6271/1 (net)	138 PS (101 KW) @ 2000 rpm
Max. Torque		57.6 kgf.m (417 lbf.ft) @ 1600 rpm	
Bore x stroke		102x120 mm (4.02"x4.72")	
Piston Displacement		5880 cc	
Battery		2x12 V x 100Ah	
Starting Motor		24 V-4.5 kW	
Alternator		24V-75A	

HYDRAULIC SYSTEM

MAIN PUMP	
Type	Two variable displacement tandem axial piston pumps
Max. flow	2 x 220 lpm (58.1 US gpm/48.4 UK gpm)
Sub-pump for pilot circuit	Gear pump

Cross-sensing & fuel saving pump system

HYDRAULIC MOTORS	
Travel	Two speed axial piston motor with counter balance valve and parking brake
Swing	Axial piston motor with automatic brake

RELIEF VALVE SETTINGS	
Implement circuits	330 kgf/cm ² (4690 psi)
Travel	330 kgf/cm ² (4690 psi)
Swing circuit	240 kgf/cm ² (3410 psi)
Pilot circuit	35 kgf/cm ² (500 psi)
Service valve	Installed

HYDRAULIC CYLINDERS	
No. of cylinder - bore x rod x stroke	Boom: 2-120 x 85 x 1,290 mm (4.7"x3.3"x50.8")
	Arm: 1-140 x 100 x 1,510 mm (5.5"x3.9"x59.4")
	Bucket: 1-125 x 85 x 1,055 mm (4.9"x3.3"x41.5")

DRIVES & BRAKES

Drive method	Fully hydrostatic type
Drive motor	Axial piston motor in-shoe design
Reduction system STD/HC	Planetary reduction gear
Max. drawbar pull	21,100 kgf (46500 lbf)
Max. travel speed (high/low)	5.3 kmph (3.3mph) / 3.4 kmph (2.1mph)
Gradeability	35° (70%)
Parking brake	Multi wet disc

CONTROL

Pilot pressure operated joysticks and pedals with detachable lever provide almost effortless and fatigueless operation.	
Pilot control	Two joysticks with one safety lever (LH): Swing and arm, (RH): Boom and bucket (ISO)
Traveling and steering	Two levers with pedals
Engine throttle	Electric, Dial type
Lights	1 x Boom, 1 x Toolbox, 2 x Cabin

SWING SYSTEM

Swing motor	Axial piston motor
Swing reduction	Planetary gear reduction
Swing bearing lubrication	Grease bathed
Swing brake	Multi wet disc
Swing speed	11 rpm

COOLANT & LUBRICANT CAPACITY

REFILLING	LITER
Fuel tank	340
Engine coolant	35
Engine oil	15
Swing device	5
Final drive (each)	5.8
Hydraulic system (Including tank)	290
Hydraulic tank	180

UNDERCARRIAGE

The X-leg type center frame is integrally welded with reinforced box-section track frames. The undercarriage includes lubricated rollers, idlers, track adjusters with shock absorbing springs and sprockets and a track chain with triple grouser shoes.	
Center frame	X-leg type
Track frame	Pentagonal box type
No. of shoes on each side	46
No. of carrier roller on each side	2
No. of track roller on each side	7
No. of rail guard on each side	1

OPERATING WEIGHT (APPROXIMATE)

Operating weight, including 5,680mm (18' 8") boom, 2,400mm (7' 10") arm, SAE heaped 0.92m ³ (1.20 yd ³) backhoe bucket, lubricant, coolant, fuel tank, hydraulic tank, operator and the standard equipment.	
MAJOR COMPONENT WEIGHT	
Upper structure	5,850kg (12,900lb)
Counter weight	3,800kg (8,380lb)
Boom (with arm cylinder)	1,950kg (4,300lb)

OPERATING WEIGHT			
Shoes		Operating weight	Ground pressure
Type	Width mm (in)	kg (lb)	kgf/cm ² (psi)
Triple grouser	500 mm (20")	20,935 (46,150)	0.57 (8.11)
	*600 mm (24")	21,200 (46,740)	0.48 (6.83)

*Standard equipment

BUCKETS

All buckets are welded with high-strength steel.

TYPES OF BUCKETS

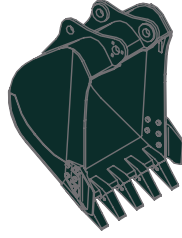

SAE
heaped

*0.92 m³ (1.20yd³)

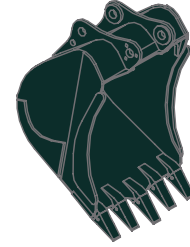

0.87 m³ (1.14 yd³)

Capacity m ³ (yd ³)		Width mm (in)		Weight kg (lb)	Recommendation mm (ft.in)		
SAE heaped	CECE heaped	Without side cutters	With side cutters		5,680 (18' 8") Boom		
					2,000 (6' 7") Arm	2,400 (7' 10") Arm	2,920 (9' 7") Arm
* 0.92 (1.20)	0.80 (1.05)	1,150 (45.3)	1,270 (50.0)	770 (1,700)	●	●	■
◎ 0.87 (1.14)	0.75 (0.98)	1,140 (44.9)	-	900 (1,980)	●	●	■

* Standard backhoe bucket
◎ Rock-Heavy duty bucket

● Applicable for materials with density of 2,000 kg / m³ (3,370 lb / yd³) or less
■ Applicable for materials with density of 1,600 kg / m³ (2,700 lb / yd³) or less

ATTACHMENT

Booms and arms are welded with a low-stress, full-box section design. 5.68m(18' 8") mono boom and 2.0m(6'7"), 2.4m(7'10"), 2.92m (9'7") Arms are available. Buckets are all-welded, high-strength steel equipments.

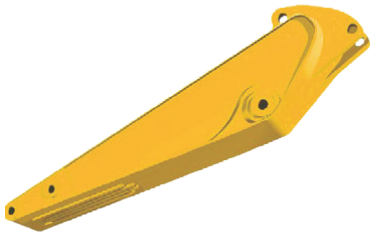

2.0 m (6'7")

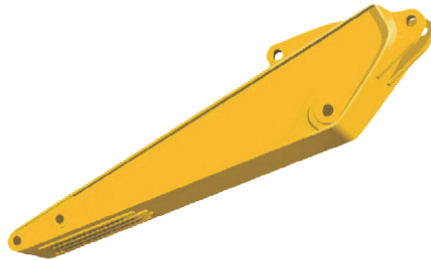

*2.40 m (7'10")

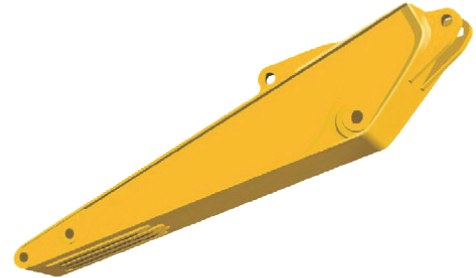

2.92 m (9'7")

DIGGING FORCE

Arm	Length	mm (ft.in)	2,000 (6' 7")	*2,400 (7' 10")	2,920 (9' 7")
	Weight	kg (lb)	860 (1,890)	950 (2,090)	990 (2,180)
Bucket digging force	SAE	kN	133.4	133.4	133.4
		kgf	13600	13600	13600
		lbf	29980	29980	29980
	ISO	kN	152.0	152.0	152.0
		kgf	15500	15500	15500
		lbf	34170	34170	34170
Arm crowd force	SAE	kN	135.3	112.8	97.1
		kgf	13800	11500	9900
		lbf	30400	25350	21830
	ISO	kN	142.2	117.7	101.0
		kgf	14500	12000	10300
		lbf	31970	26460	22710

Note: Arm weight includes bucket cylinder, linkage, and pin

*Standard arm

Dimensions & Working Range

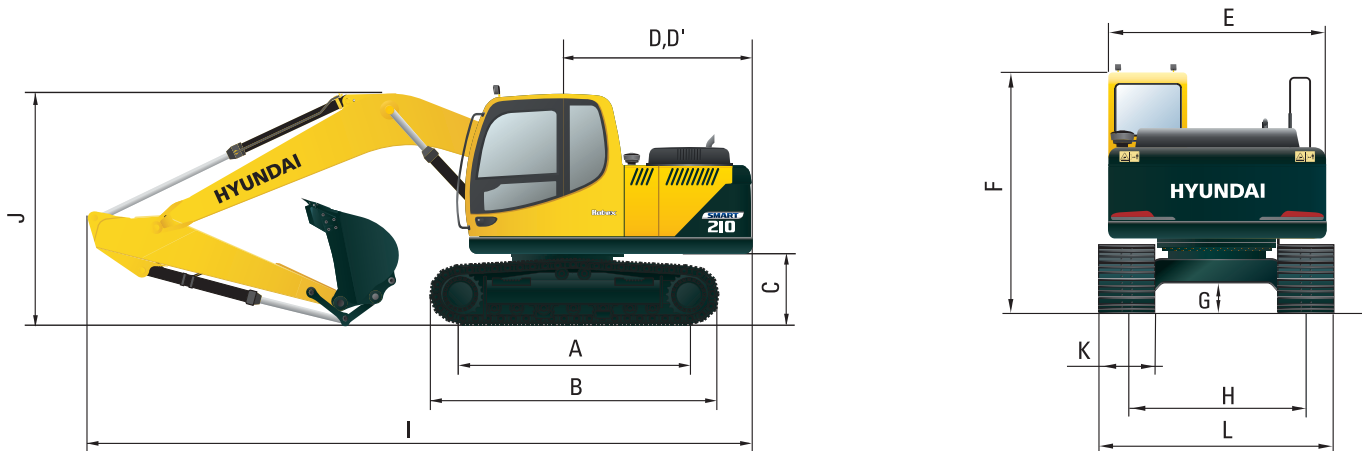

DIMENSIONS	mm (ft.in)
A Tumbler distance	3370 (11' 1")
B Overall length of crawler	4160 (13' 8")
C Ground clearance of counterweight	1060 (3' 6")
D Tail swing radius	2830 (9' 3")
D' Rear-end length	2770 (9' 1")
E Overall width of upperstructure	2700 (8' 10")
F Overall height of cab	2920 (9' 7")
G Min. ground clearance	480 (1' 7")
H Track gauge	2200 (7' 3")

DIMENSIONS	mm (ft.in)		
BOOM LENGTH (STD.)	*5680 (18' 8")		
ARM LENGTH	2000 (6' 7")	*2400 (7' 10")	2920 (9' 7")
I Overall length	9650 (31' 8")	9570 (31' 5")	9520 (31' 3")
J Overall height of boom	3200 (10' 6")	3110 (10' 2")	2990 (9' 10")
K Track shoe width	500 (20")	*600 (24")	
L Overall width	2700 (8' 10")	2800 (9' 2")	

*Standard equipment

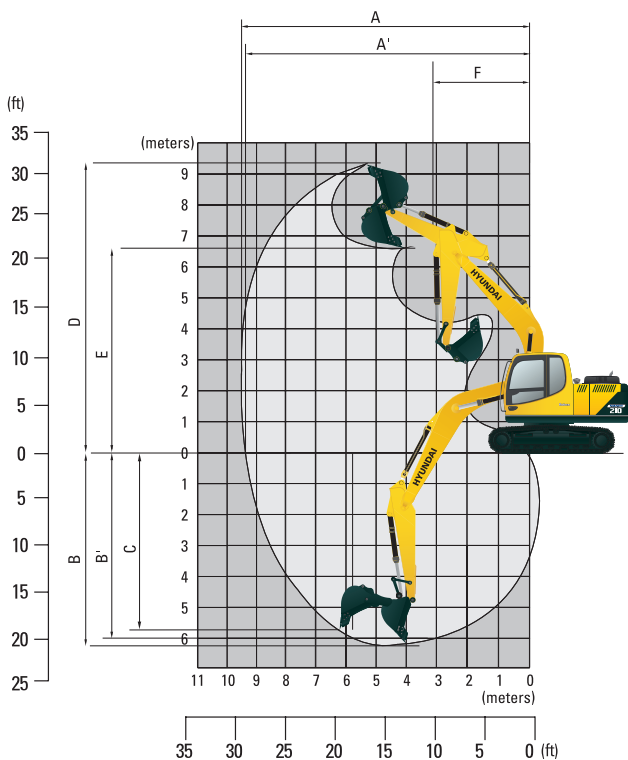



DIMENSIONS	mm (ft.in)		
BOOM LENGTH (STD.)	*5680 (18' 8")		
ARM LENGTH	2000 (6' 7")	*2400 (7' 10")	2920 (9' 7")
A Maximum digging reach	9140 (30' 0")	9500 (31' 2")	9940 (32' 7")
A' Maximum digging reach on ground	8960 (29' 5")	9330 (30' 7")	9780 (32' 1")
B Maximum digging depth	5820 (19' 1")	6220 (20' 5")	6740 (22' 1")
B' Maximum digging depth (B' level)	5580 (18' 4")	6010 (19' 9")	6550 (21' 6")
C Maximum Vertical wall digging depth	5280 (17' 4")	5720 (18' 9")	6120 (20' 1")
D Maximum digging height	9140 (30' 0")	9340 (30' 8")	9470 (31' 1")
E Maximum dumping height	6330 (20' 9")	6520 (21' 5")	6670 (21' 11")
F Minimum swing radius	3750 (12' 4")	3740 (12' 3")	3640 (11' 11")











*Standard equipment













Lifting capacities













LIFTING CAPACITIES 210 SMART

 Rating over-front

 Rating over-side or 360 degree











Boom: 5.68 m (18' 8") / Arm: 2.0 m (6' 7") / Bucket: 0.92 m ³ (1.20 yd ³) SAE heaped / Shoe: 500mm(20") triple grouser with 3,800kg (8,380 lb) counterweight													
Load point height m (ft)		Load radius								At max. reach			
		3.0 m (10.0 ft)		4.5 m (15.0 ft)		6.0 m (20.0 ft)		7.5 m (25.0 ft)		Capacity		Reach m (ft)	
													
7.5m (25.0ft)	kg lb										*3750 *8270	*3750 *8270	6.64 (21.8)
6.0m (20.0ft)	kg lb					*4150 *9150	*4150 *9150				*3800 *8380	2900 6390	7.78 (25.5)
4.5m (15.0ft)	kg lb			*5360 *11820	*5360 *11820	*4540 *10010	4420 9740				*3910 *8620	2420 5340	8.43 (27.7)
3.0m (10.0ft)	kg lb			*6970 *15370	6520 14370	*5240 *11550	4160 9170	*4500 *9920	2850 6280	3830 8440	2200 4850	8.74 (28.7)	
1.5m (5.0ft)	kg lb			*8380 *18470	6000 13230	*5950 *13120	3910 8620	4790 10560	2740 6040	3770 8310	2150 4740	8.73 (28.6)	
Ground Line	kg lb			*9020 *19890	5770 12720	*6430 *14180	3740 8250	4700 10360	2660 5860	3980 8770	2260 4980	8.42 (27.6)	
-1.5m (-5.0ft)	kg lb	*13020 *28700	11600 25570	*8960 *19750	5740 12650	*6510 *14350	3690 8140			*4550 *10030	2610 5750	7.76 (25.5)	
-3.0m (-10.0ft)	kg lb	*11620 *25620	*11620 *25620	*8210 *18100	5850 12900	*5910 *13030	3780 8330			*4510 *9940	3470 7650	6.61 (21.7)	
-4.5m (-15.0ft)	kg lb	*8770 *19330	*8770 *19330										













Boom: 5.68 m (18' 8") / Arm: 2.4 m (7' 10") / Bucket: 0.92 m ³ (1.20 yd ³) SAE heaped / Shoe: 500mm(20") triple grouser with 3,800kg (8,380 lb) counterweight														
Load point height m (ft)		Load radius								At max. reach				
		1.5 m (5.0 ft)		3 m (10.0 ft)		4.5 m (15 ft)		6.0 m (20.0 ft)		7.5 m (25.0 ft)		Capacity		Reach m (ft)
														
7.5m (25.0ft)	kg lb											*3450 *7610	*3450 *7610	7.15 (23.5)
6.0m (20.0ft)	kg lb							*3750 *8270	*3750 *8270			*3520 *7760	2630 5800	8.20 (26.9)
4.5m (15.0ft)	kg lb							*4190 *9240	*4190 *9240	*3940 *8690	2970 6550	*3630 *8000	2220 4890	8.82 (28.9)
3.0m (10.0ft)	kg lb					*6420 *14150	*6420 *14150	*4920 *10850	4190 9240	*4240 *9350	2860 6310	3560 7850	2020 4450	9.11 (29.9)
1.5m (5.0ft)	kg lb					*7960 *17550	6040 13320	*5690 *12540	3910 8620	*4620 *10190	2720 6000	3500 7720	1970 4340	9.10 (29.9)
Ground Line	kg lb			*8300 *18300	*8300 *18300	*8820 *19440	5730 12630	*6260 *13800	3710 8180	4670 10300	2620 5780	3670 8090	2060 4540	8.81 (28.9)
-1.5m (-5.0ft)	kg lb	*9220 *20330	*9220 *20330	*12750 *28110	11370 25070	*8970 *19780	5650 12460	*6460 *14240	3630 8000			4140 9130	2350 5180	8.18 (26.8)
-3.0m (-10.0ft)	kg lb	*13340 *29410	*13340 *29410	*12280 *27070	11580 25530	*8430 *18580	5730 12630	*6110 *13470	3670 8090			*4360 *9610	3020 6660	7.12 (23.4)
-4.5m (-15.0ft)	kg lb			*9840 *21690	*9840 *21690	*6850 *15100	5980 13180							













Boom: 5.68 m (18' 8") / Arm: 2.92 m (9' 7") / Bucket: 0.92 m ³ (1.20 yd ³) SAE heaped / Shoe: 500mm(20") triple grouser with 3,800kg (8,380 lb) counterweight																
Load point height m (ft)		Load radius								At max. reach						
		1.5 m (5.0 ft)		3 m (10.0 ft)		4.5 m (15 ft)		6.0 m (20.0 ft)		7.5 m (25.0 ft)		Capacity		Reach m (ft)		
																
7.5m (25.0ft)	kg lb												*3120 *6880	3080 6790	7.72 (25.3)	
6.0m (20.0ft)	kg lb												*3210 *7080	2390 5270	8.69 (28.5)	
4.5m (15.0ft)	kg lb							*3770 *8310	*3770 *8310	*3590 *7910	3040 6700	*3340 *7360	2040 4500	9.27 (30.4)		
3.0m (10.0ft)	kg lb					*9160 *20190	*9160 *20190	*5760 *12700	*5760 *12700	*4530 *9990	4270 9410	*3950 *8710	2900 6390	3300 7280	1860 4100	9.55 (31.3)
1.5m (5.0ft)	kg lb					*8660 *19090	*8660 *19090	*7430 *16380	6180 13620	*5380 *11860	3960 8730	*4390 *9680	2750 6060	3240 7140	1810 3990	9.54 (31.3)
Ground Line	kg lb			*9310 *20530	*9310 *20530	*8550 *18850	5780 12740	*6060 *13360	3730 8220	4670 10300	2620 5780	3370 7430	1870 4120	9.26 (30.4)		
-1.5m (-5.0ft)	kg lb	*8550 *18850	*8550 *18850	*12160 *26810	11240 24780	*8950 *19730	5630 12410	*6400 *14110	3610 7960	4590 10120	2560 5640	3740 8250	2100 4630	8.67 (28.4)		
-3.0m (-10.0ft)	kg lb	*11700 *25790	*11700 *25790	*13020 *28700	11400 25130	*8680 *19140	5640 12430	*6280 *13850	3600 7940			*4230 *9330	2610 5750	7.69 (25.2)		
-4.5m (-15.0ft)	kg lb			*11040 *24340	*11040 *24340	*7560 *16670	5820 12830						*4140 *9130	3950 8710	6.09 (20.0)	

Lifting capacities

 Rating over-front  Rating over-side or 360 degree

Boom: 5.68 m (18' 8") / Arm: 2.0 m (6' 7") / Bucket: 0.92 m ³ (1.20yd ³) SAE heaped / Shoe: 600mm(24") triple grouser with 3,800kg (8,308 lb) counterweight													
Load point height m (ft)		Load radius								At max. reach			
		3.0 m (10.0 ft)		4.5 m (15.0 ft)		6.0 m (20.0 ft)		7.5 m (25.0 ft)		Capacity		Reach m (ft)	
													
7.5m (25.0ft)	kg lb										*3750 *8270	*3750 *8270	6.64 (21.8)
6.0m (20.0ft)	kg lb					*4150 *9150	*4150 *9150				*3800 *8380	2910 6420	7.78 (25.5)
4.5m (15.0ft)	kg lb			*5360 *11820	*5360 *11820	*4540 *10010	4440 9790				3620 7980	2430 5360	8.43 (27.7)
3.0m (10.0ft)	kg lb			*6970 *15370	6540 14470	*5240 *11550	4180 9220	4280 9440	2870 6330		3340 7360	2210 4870	8.74 (28.7)
1.5 m (5.0ft)	kg lb			*8380 *18470	6020 13270	*5930 *13070	3920 8640	4160 9170	2750 6060		3280 7230	2160 4760	8.73 (28.6)
Ground Line	kg lb			*9020 *19890	5790 12760	*5750 *12680	3760 8290	4070 8970	2680 5910		3460 7630	2270 5000	8.42 (27.6)
-1.5m (-5.0ft)	kg lb	*13020 *28700	11630 25640	*8960 *19750	5760 12700	*5690 *12540	3710 8180				3960 8730	2620 5780	7.76 (25.5)
-3.0m (-10.0ft)	kg lb	*11620 *25620	*11620 *25620	*8210 *18100	5870 12940	*5790 *12760	3800 8380				*4510 *9940	3480 7670	6.61 (21.7)
-4.5m (-15.0ft)	kg lb	*8770 *19330	*8770 *19330										

Boom: 5.68 m (18' 8") / Arm: 2.4 m (7' 10") / Bucket: 0.92 m ³ (1.20yd ³) SAE heaped / Shoe: 600mm(24") triple grouser with 3,800kg (8,308 lb) counterweight															
Load point height m (ft)		Load radius								At max. reach					
		1.5 m (5.0 ft)		3 m (10.0 ft)		4.5 m (15 ft)		6.0 m (20.0 ft)		7.5 m (25.0 ft)		Capacity		Reach m (ft)	
															
7.5m (25.0ft)	kg lb											*3450 *7610	*3450 *7610	7.15 (23.5)	
6.0m (20.0ft)	kg lb							*3750 *8270	*3750 *8270				*3520 *7760	2640 5820	8.20 (26.9)
4.5m (15.0ft)	kg lb							*4190 *9240	*4190 *9240	*3940 *8690	2990 6590		3350 7390	2230 4920	8.82 (28.9)
3.0m (10.0ft)	kg lb					*6420 *14150	*6420 *14150	*4920 *10850	4210 9280	*4240 *9350	2870 6330		3090 6810	2030 4480	9.11 (29.9)
1.5 m (5.0ft)	kg lb					*7960 *17550	6060 13360	*5690 *12540	3930 8660	4140 9130	2740 6040		3040 6700	1980 4370	9.10 (29.9)
Ground Line	kg lb			*8300 *18300	*8300 *18300	*8820 *19440	5760 12700	*5720 *12610	3730 8220	4040 8910	2640 5820		3180 7010	2070 4560	8.81 (28.9)
-1.5m (-5.0ft)	kg lb	*9220 *20330	*9220 *20330	*12750 *28110	11400 25130	*8970 *19780	5670 12500	5630 12410	3650 8050				3590 7910	2360 5200	8.18 (26.8)
-3.0m (-10.0ft)	kg lb	*13340 *29410	*13340 *29410	*12280 *27070	11620 25620	*8430 *18580	5750 12680	5680 12520	3690 8140				*4360 *9610	3030 6680	7.12 (23.4)
-4.5m (-15.0ft)	kg lb			*9840 *21690	*9840 *21690	*6850 *15100	6000 13230								

Boom: 5.68 m (18' 8") / Arm: 2.92 m (9' 7") / Bucket: 0.92 m ³ (1.20yd ³) SAE heaped / Shoe: 600mm(24") triple grouser with 3,800kg (8,308 lb) counterweight																
Load point height m (ft)		Load radius								At max. reach						
		1.5 m (5.0 ft)		3 m (10.0 ft)		4.5 m (15 ft)		6.0 m (20.0 ft)		7.5 m (25.0 ft)		Capacity		Reach m (ft)		
																
7.5m (25.0ft)	kg lb												*3120 *6880	3090 6810	7.15 (25.3)	
6.0m (20.0ft)	kg lb												*3210 *7080	2400 5290	8.69 (28.5)	
4.5m (15.0ft)	kg lb							*3770 *8310	*3770 *8310	*3590 *7910	3060 6750		3090 6810	2050 4520	9.27 (30.4)	
3.0m (10.0ft)	kg lb					*9160 *20190	*9160 *20190	*5760 *12700	*5760 *12700	*4530 *9990	4290 9460		*3950 *8710	2920 6440	1870 4120	9.55 (31.3)
1.5 m (5.0ft)	kg lb					*8660 *19090	*8660 *19090	*7430 *16380	6200 13620	*5380 *11860	3980 8770	4170 9190	2760 6080	2810 6190	1820 4010	9.54 (31.3)
Ground Line	kg lb			*9310 *20530	*9310 *20530	*8550 *18850	5800 12790	5740 12650	3750 8270	4040 8910	2630 5800		2920 6440	1880 4140	9.26 (30.4)	
-1.5m (-5.0ft)	kg lb	*8550 *18850	*8550 *18850	*12160 *26810	11270 24850	*8950 *19730	5650 12460	5610 12370	3620 7980	3970 8750	2570 5670		3240 7140	2110 4650	8.67 (28.4)	
-3.0m (-10.0ft)	kg lb	*11700 *25790	*11700 *25790	*13020 *28700	11430 25200	*8680 *19140	5660 12480	5600 12350	3620 7980				3970 8750	2620 5780	7.69 (25.2)	
-4.5m (-15.0ft)	kg lb			*11040 *24340	*11040 *24340	*7560 *16670	5840 12870							*4140 *9130	3970 8750	6.09 (20.0)

- Lifting capacity is based on SAE J1097, ISO 10567.
- Lifting capacity of the Robex Series does not exceed 75% of the tipping load with the machine on firm, level ground or 87% of full hydraulic capacity.
- The load point is a hook located on the back of the bucket.
- (*) indicates the load limited by hydraulic capacity.

HYUNDAI INDIA

Network

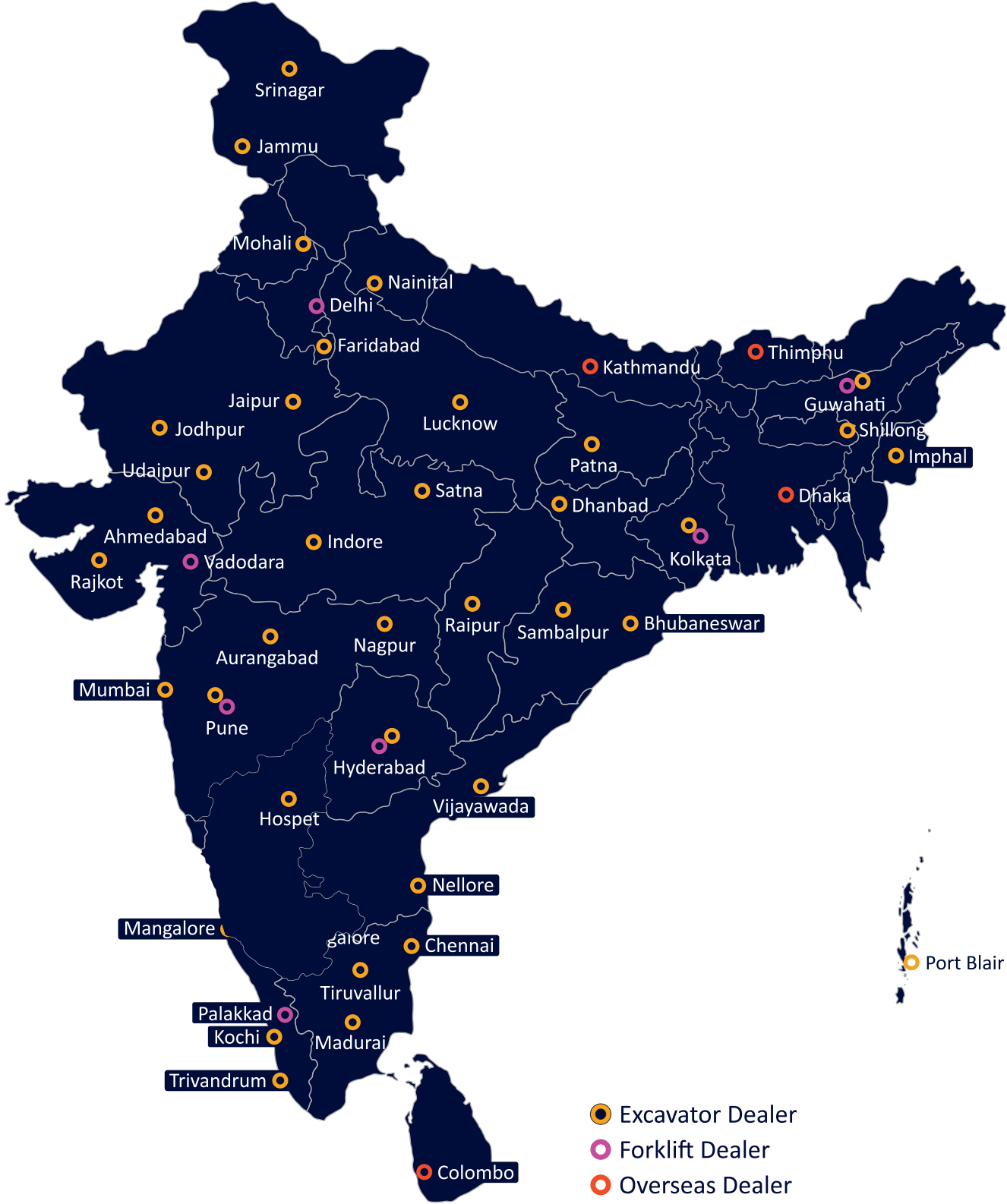

Disclaimer: All the locations marked on the map are of dealers' head offices

GENUINE PARTS

Developed in synergy with our machines, Hyundai parts and lubricants ensure that you get the high levels of performance, reliability and safety that come with the complete Hyundai experience.

- » Enjoy the confidence and assurance of the most stringent testing procedures and the high quality manufacturing processes safeguarding your machine's health
- » Experience the versatility of our 190+ strong outlet network across India

Why risk it?

Maximize profits and extend your machine's life.

Be SURE
Be SAFE
Be SMART
Use only

HYUNDAI GENUINE PARTS

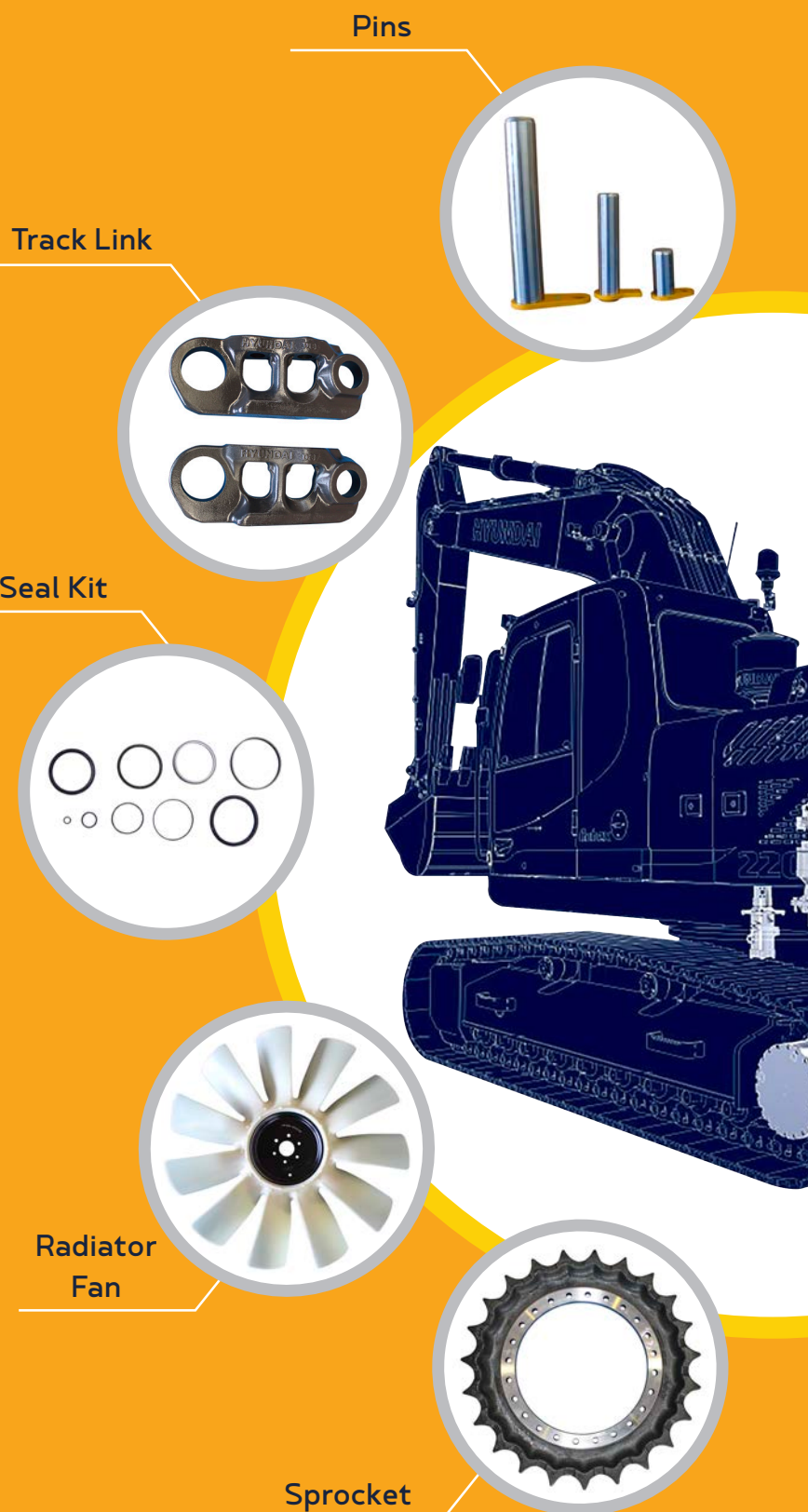

Idler



Filters

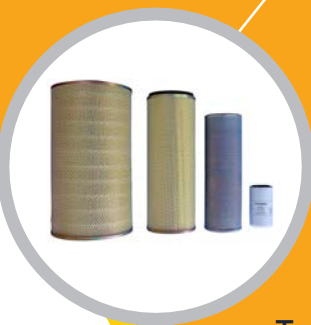

Tooth Points

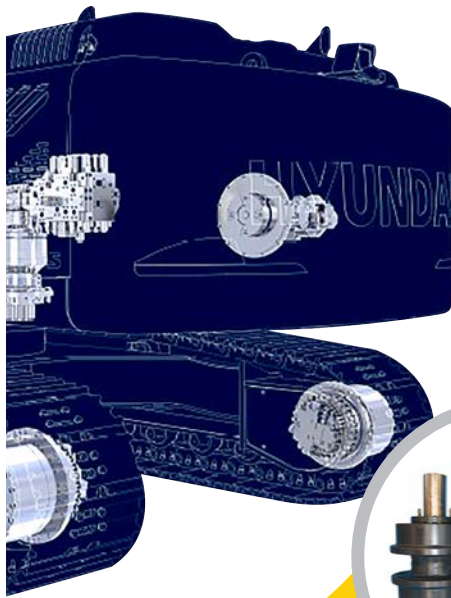

Rollers



Track Shoe

BENEFITS OF USING GENUINE HYUNDAI PARTS AND LUBRICANTS:

- » Genuine Hyundai Parts meet strict specifications and standards in Chemistry, Microstructure and Tensile Strength.
- » Benefit from the continuous improvements and advancements made by Hyundai's technical team
- » Improved performance of hydraulics and engine components
- » Enjoy greater productivity with higher uptime
- » Higher resale values
- » Reduced oil consumption and unexpected breakdowns
- » Enhanced component life

RISKS OF USING NON GENUINE PARTS:

- » Sub standard parts may lead to recurring issues
- » Frequent wear and high failure risks
- » Increased repair and service costs
- » Damage of associated parts and fitment issues
- » Damage to the entire system due to a single non-genuine part
- » Unreliable operation and safety hazards
- » Limitation of warranty coverage



Standard Equipment

ISO standard cabin

- All-weather steel cab with all-around visibility
- Safety glass windows
- Rise-up type windshield wiper
- Sliding fold-in front window
- Sliding side window
- Lockable door
- Rear open window
- Accessory box & Ashtray

Computer Aided Power Optimization (New CAPO) system

- 2-power mode, 2-work mode
- Auto deceleration & one touch deceleration system
- Auto overheat prevention system

Self diagnostic system

Cabin lights (2 Nos)

Centralized monitoring

- LCD display
 - Engine speed
 - Clock & Error code
- Gauges
 - Fuel level gauge
 - Engine coolant temperature gauge
 - Hyd. oil temperature gauge
- Warning
 - Fuel level
 - CPU
 - Engine oil pressure
 - Engine coolant temperature
 - Hyd. oil temperature
 - Low battery
 - Air cleaner clogging
- Indicator
 - One touch decel

Tool kit

Door and cab locks, one key

One outside rearview mirror

Fully adjustable suspension seat

Slidable joystick, pilot-operated

Two front working lights

Electric horn

Batteries (2 x 12V x 100 AH)

Battery master switch

Removable clean out screen for oil cooler

Automatic swing brake

Removable reservoir tank

Fuel pre-filter

Boom holding system

Arm holding system

Fuel saving kit

Counterweight (3800kg, 8380lb)

Mono boom (5.68m, 18' 8")

Arm (2.4m, 7'10")

Standard bucket (0.92m³, 1.20yd³)

Track shoes (600mm, 24")

Track rail guard

Operator kit

Optional Equipment

Air-conditioner (5,000 kcal/hr, 20,000 BTU/hr)

Sun visor for cabin inside

Cabin front protector

Fuel filler pump (35 l/min, 9.5 US gpm)

Beacon lamp

Single acting piping kit (breaker, etc)

Double acting piping kit (clamshell, etc)

Quick coupler

Fan

Various optional Arms

- Arm (2.00 m, 6' 7")
- Arm (2.92 m, 9' 7")

Various optional Buckets (SAE heaped)

- Rock bucket (0.87 m³, 1.14yd³)

Cabin FOPS/FOG(ISO/DIS 10262)

- FOPS(Falling Object Protective Structure)
- FOG(Falling Object Guard)

Track shoes

- Triple grousers shoe (500 mm, 20")

Standard and optional equipment may vary. Contact your Hyundai dealer for more information. The machine shown may vary according to International standards. All US measurement rounded off to nearest pounds or inches.



Head Office : Plot No. A-2, M.I.D.C Chakan, Phase II, Village: Khalumbre, Taluka: Khed, Dist.: Pune- 410501
Email Id: hyundai.care@theconnectionsindia.com
 Tel. No.: 02135-301700 Fax. No.: 02135-301712
 Toll Free No.: 18002098600

Regional Office North : Delhi Contact No. +91 11 45604521
Regional Office East : Kolkata Contact No. +913330581802
Regional Office South : Bengaluru Contact No. +91 08032521723
Regional Office West : Mumbai Contact No. +91 22 40240320

PLEASE CONTACT

<http://www.hyundaiindia.net>